

Profil LED / Profile LED

CLARO

Karta produktu Data sheet

PL

Profil nawierzchniowy – do podświetlenia pomieszczeń domowych i przestrzeni biurowych. Do zastosowania w postaci lampy wiszącej, z ukrytym zasilaczem.

EN

Surface-mounted profile – for household and office room illumination – to be used as a pendant lamp with a hidden power supply.

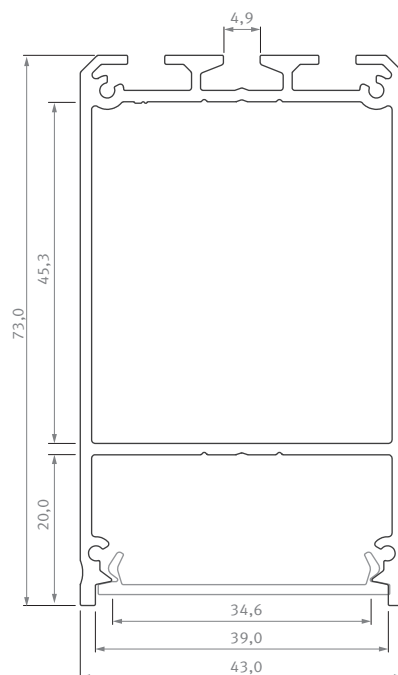

Sposoby montażu /
Assembly methods

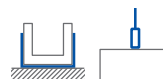



Obejrzyj wideo /
Watch video



CLARO

Profil LED / Profile LED

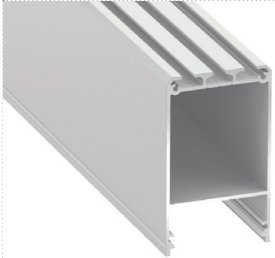
Wymiary [mm] / Dimensions (mm): 1000, 2020, 3000

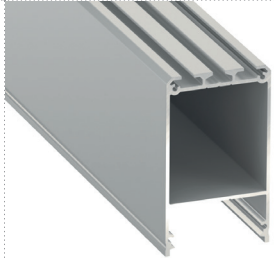

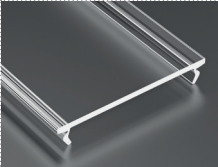
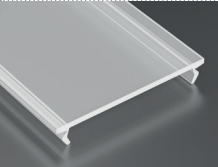
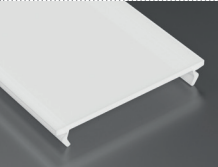
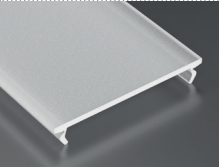
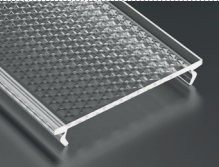
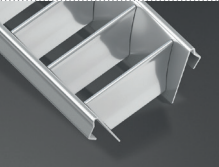

	BIAŁY (lakierowany) white (lacquered)	CZARNY (lakierowany) black (lacquered)	SREBRNY (anodowany) silver (anodized)
Kolory profili Profile colors			
1,0 m	10-0601-10	10-0000-06	10-0604-10
2,02 m	10-0601-20	10-0000-07	10-0604-20
3,0 m	10-0601-30	10-0000-08	10-0604-30
Szerokość taśmy LED (mm) LED strip width (mm)	3 × 12		

Klosze (PVC/PMMA/PC) / Covers



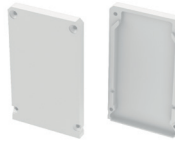

Wymiary [mm] / Dimensions (mm): 1000, 2020, 3000

TRANSPARENTNY transparent	MROŻONY frozen	MLECZNY milky	FROSTED MLECZNY milky frosted	TRANSPARENTNY transparent	SREBRNY silver
WIDE				PRISMATIC PC	
					
1 m/PMMA 11-2033-10 1 m/PC 11-3033-10	1 m/PMMA 11-2032-10 1 m/PC 11-3032-10	1 m/PMMA 11-2031-10 1 m/PC 11-3031-10	1 m/PMMA 11-2036-10	1 m/PC 11-3034-10	1m/ 14-7068-00

Zaślepki (aluminium) / End caps (aluminum)

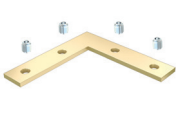
Z OTWOREM with a hole			BEZ OTWORU without a hole		
BIAŁY white	CZARNY black	SREBRNY silver	BIAŁY white	CZARNY black	SREBRNY silver
CLARO					
					
ALU 12-1141-10	ALU 12-0000-54	ALU 12-1145-10	ALU 12-1141-11	ALU 12-0000-53	ALU 12-1145-11

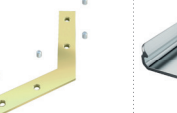
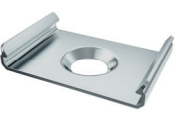
Dodatki / Accessories

ŁĄCZNIK PROSTY straight connector	ŁĄCZNIK KĄTOWY 90° angular connector 90°	ŁĄCZNIK POPRZECZNY KĄTOWY angular transverse connector	ŁĄCZNIK KĄTOWY 120° angular connector 120°	UCHWYT A METALOWY metal mounting clip	UCHWYT NA PRZEWÓD fi 5 mm cable fi 5 mm holder	ZAWIESIA pendants
						
14-3032-02	14-3030-01	14-3038-01	14-3036-01	13-0210-02	*T 14-7067-00 *B 14-7067-02	*S 14-2011-02 *B 14-2076-00 *W 14-2075-00

* S SREBRNY silver; * B CZARNY black; * T TRANSPARENTNY transparent; * W BIAŁY white

Maksymalna rozpraszana moc źródeł światła LED

Maximum dissipated power of LED light sources

dla temperatury profilu for temperature profile 55° C	dla temperatury profilu for temperature profile 65° C
55,3 W	69,9 W

LUMINES[®]
LIGHTING

www.lumines.pl

